



JVC

AV-28KM3SN

ENGLISH
DEUTSCH
SVENSKA
DANSK
NORSK
SUOMI

JVC

COLOUR TELEVISION

INSTRUCTIONS

FARBFERNSEHGERÄT
FÄRG- TV
FARVEFJERNSYN
FARGEFJERNSYN
VÄRITELEVISIO

BEDIENUNGSANLEITUNG
BRUKSANVISNING
INSTRUKTIONSBOG
BRUKSANVISNING
KÄYTTÖOHJE



50028493



0307-TKH-VT-VT



Contents

Safety Precautions	1
Remote Control Buttons	2
Control Panel Buttons	3
Antenna Connections	3
Preparation	4
Features	4
Before Switching on your TV	4
Power connection	4
Aerial Connections	4
How to connect the external equipments	4
Inserting batteries in the remote control handset	4
Switching the TV ON/OFF	4
To switch the TV on	4
To switch the TV off	4
Initial Settings	4
Operating with the onset buttons	5
Operating with Remote Control	5
Menu System	5
Sound Menu	5
Picture Menu	6
Feature Menu	7
Install. Menu	7
Program. (Programming) Menu	8
Other Features	9
Sound Mute	9
Information on Screen	9
To Display the Time	9
Standard	9
VCR Control Buttons	9
Teletext	9
To operate Teletext	9
To select a page of Teletext	9
To Select Index Page	10
Searching for a teletext page while watching TV	10
To Select Double Height Text	10
To Reveal "concealed" Information	10
To Stop Automatic Page Change	10
To Select a Subcode Page	10
To exit Teletext	10
Fastext and Toptext	10
Connect the External Equipments	11
Via the Euroconnector	12
RGB mode	12
AV-2 S Mode	12
Via the RCA jacks	12
Via the ANT (aerial) socket	12
TV and Video Recoder (VCR)	12
NTSC Playback	12
Copy Facility	12
Connecting Headphones	12
Tips	12
Specifications	13

Safety Precautions

1. Power Source

The receiver should be operated only from a **220-240V AC, 50 Hz.** outlet. Ensure you select the correct voltage setting for your convenience.

2. Power Cord

The power supply cord should be placed so that they are not likely to be walked on or pinched by items placed upon them or against them. Pay particular attention to cord where they enter the plug, power outlet, and the point where they exit from the receiver.

3. Moisture and Water

Do not use this equipment in a humid and damp place (avoid the bathroom, the sink in the kitchen, and near the washing machine). Do not expose this equipment to rain or water and do not place objects filled with liquids on it as this may be dangerous.

4. Cleaning

Before cleaning, unplug the receiver from the main supply outlet. Do not use liquid or aerosol cleaners. Use with soft and dry cloth.

5. Ventilation

The slots and openings on the receiver are intended for ventilation and to ensure reliable operation. To prevent overheating, these openings must not be blocked or covered in anyway.

6. Lightning

In case of storm and lightning or when going on holiday, disconnect the power cord from the wall outlet.

7. Replacement Part

When replacement parts are required, be sure the service technician has used replacement parts which are specified by the manufacturer or have the same specifications as the original one. Unauthorized substitutions may result in fire, electrical shock, or other hazards.

8. Servicing

Please refer all servicing to qualified personnel. Do not remove cover as this may result in electric shock.

9. Flame sources

Do not place naked flame sources on the apparatus.

10. Stand-By

Do not leave your TV stand-by or operating condition when you leave your house.

Warning!

Any intervention contrary to regulations, in particular, any modification of high voltage or a replacement of the picture tube may lead to an increased concentration of x-rays. Any television modified in this way no longer complies with license and must not be operated.

Instructions for waste disposal:

Packaging and packaging aids are recyclable and should principally be recycled. Packaging materials, such as foil bag, must be kept away from children.

Make enough room for inserting and removing the power plug! Place the TV as close to the outlet as possible!

The main power supply for this TV is controlled by inserting or removing the power plug.

Remote Control Buttons

- ① = Stand By / Power
- ② **0 - 9** = Direct Program
- ③ Standard Button (PICTURE default settings)
- ④ Colour Buttons
- ⑤ **MENU** = Menu Button
- ⑥ **▲ (P^)** = Cursor Up / Programme Up
- ⑦ **▶ (⇨)** = Cursor Right / Volume +
- ⑧ Teletext Control Buttons
- ⑨ VCR Control Buttons
- ⑩ **▼ (P∨)** = Cursor Down / Programme Down
- ⑪ **◀ (⇦)** = Cursor Left / Volume -
- ⑫ **AV** = AV Button
- ⑬ **i** = Information Button
- ⑭ = Mute

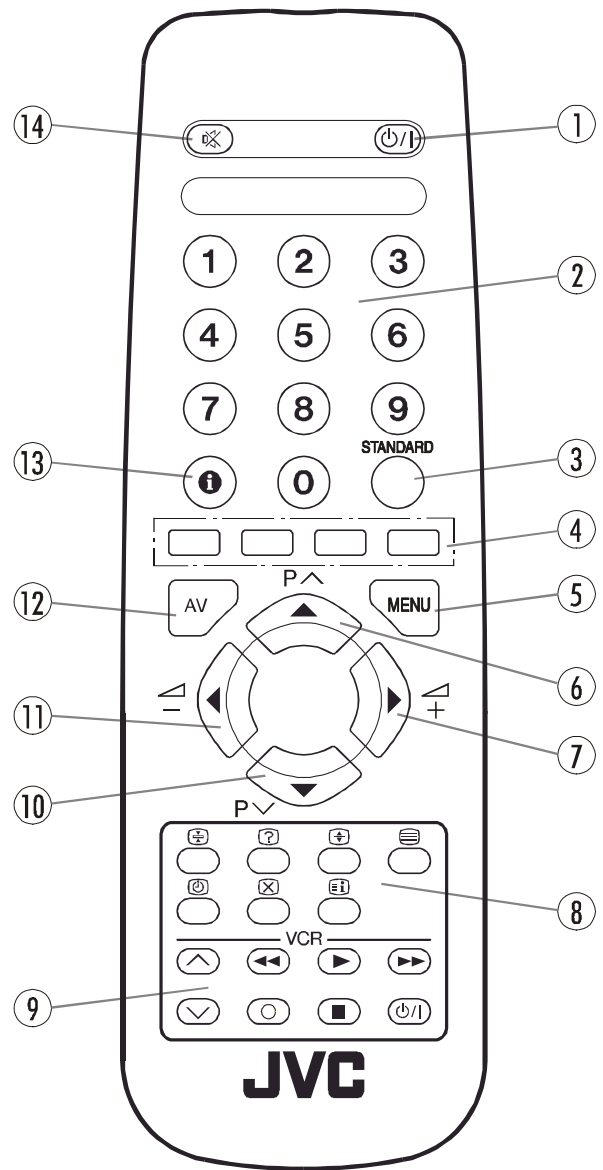

CAUTION RISK OF ELECTRIC SHOCK



The lightning flash with arrowhead symbol, within an equilateral triangle, is intended to alert the user to the presence of uninsulated "dangerous voltage" within the product's enclosure that may be of sufficient magnitude to constitute a risk of electric shock of persons.

The exclamation point within an equilateral triangle is intended to alert the user to the presence of important operating and maintenance (servicing) instructions in the literature accompanying the appliance.

Control Panel Buttons

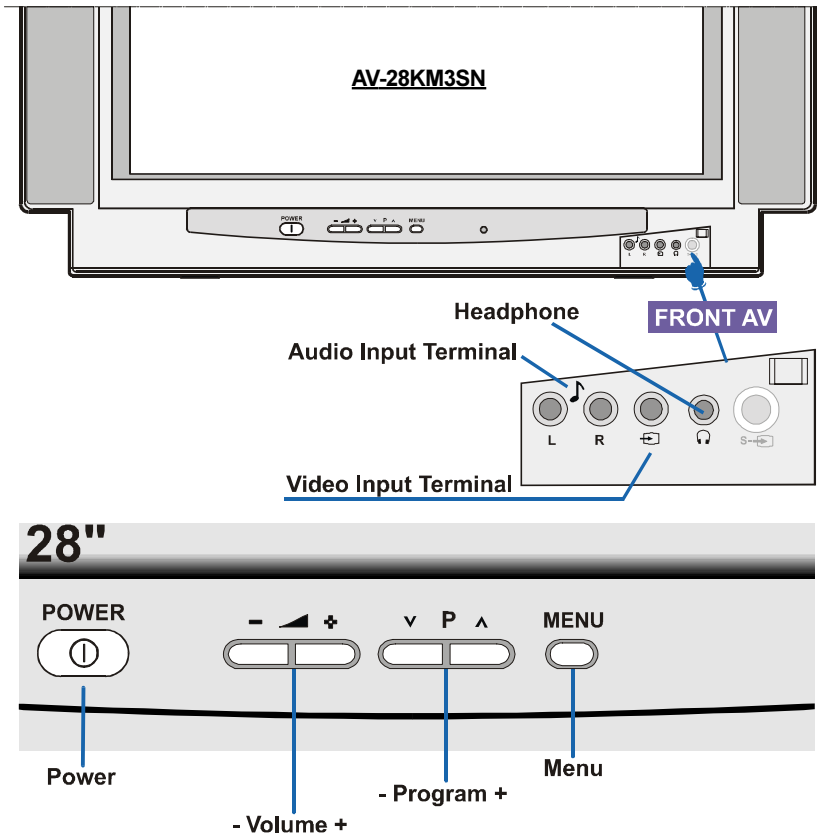

28"

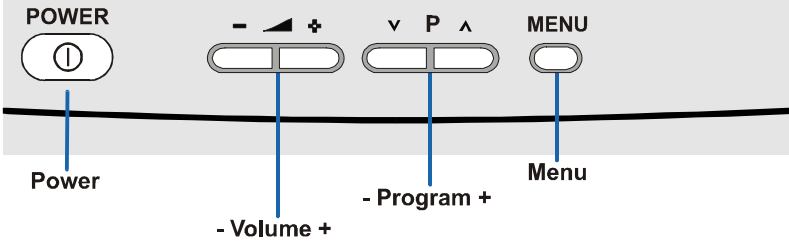

Antenna Connections

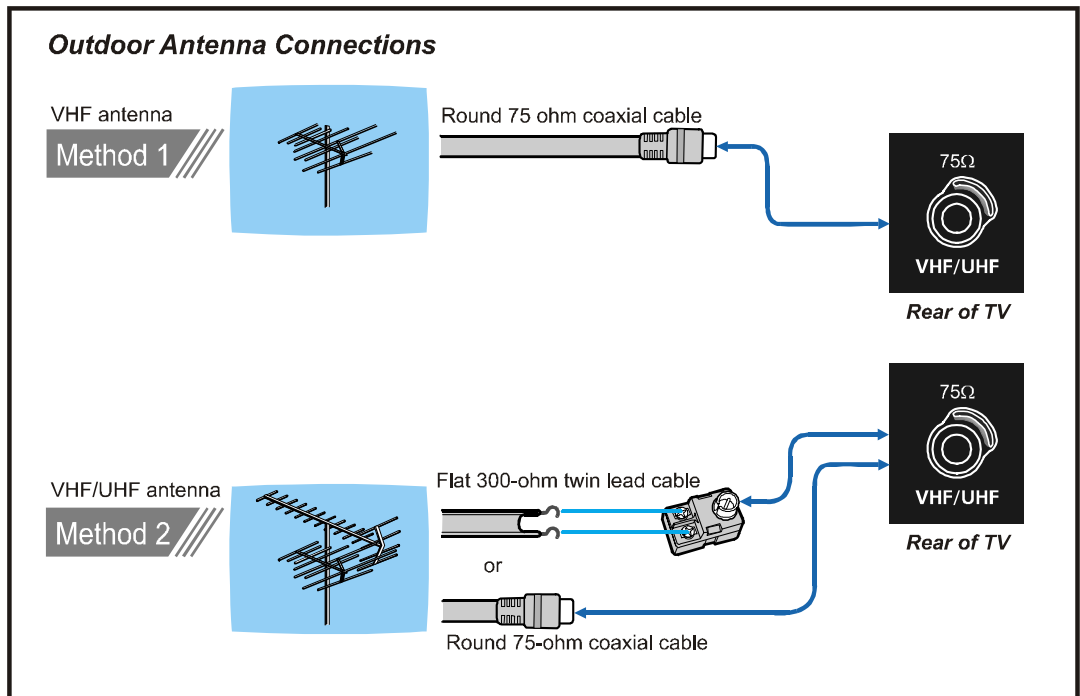

Preparation

Place TV on a solid surface.

For ventilation, leave a space of at least 10 cm free all around the set. To prevent any fault and unsafe situations, please do not place any objects on top of the set.

Features

- It is a remote controlled colour television.
- 100 programmes from VHF, UHF bands or cable channels can be preset.
- It can tune cable channels.
- Controlling the TV is very easy by its menu driven system.
- It has two Euroconnector sockets for external devices (such as video recorder, video games, audio set, etc.)
- Front AV Input available.
- Stereo sound systems (German+Nicam) are available.
- Full function Teletext (Fastext, Toptext).
- It is possible to connect headphone.
- Direct channel access.
- APS (Automatic Programming System).
- All programmes can be named.
- Forward or backward automatic tuning.
- Sleep timer.
- Child Lock.
- Automatic sound mute when no transmission.
- 5 minutes after the broadcasting (closedown), the TV switches itself automatically to stand-by mode.

Before Switching on your TV

Power connection

Important: The TV set is designed to operate on **220-240 V AC, 50 Hz**.

- After unpacking, allow the TV set to reach the ambient room temperature before you connect the set to the mains.

Aerial Connections

- Connect the aerial plug to the aerial input socket located at the back of the TV.

How to connect the external equipments

See "**Connect the External Equipments**" on **page 11**.

- See the instruction manuals provided with the external devices too.

Inserting batteries in the remote control handset

- Remove the battery cover located on the back of the handset by gently pulling upwards from the indicated part.
- Insert two **AA (R6)** or equivalent type batteries inside.
- Replace the battery cover.

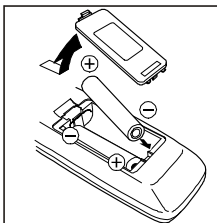

NOTE: Remove batteries from remote control handset when it is not to be used for a long period. Otherwise it can be damaged due to any leakage of batteries.

Switching the TV ON/OFF

You can operate your TV either using the remote control handset or directly using the TV onset buttons.

To switch the TV on

Your TV will switch on in two steps:

1- Press the power button located on the front of the TV. Then the TV switches itself to standby mode and the **RED LED** located below the TV turns on.

2- To switch on the TV from stand-by mode either:

Press a digit button on the remote control so that a programme number is selected,

or,

Press Standby / Power Button or Programme Up and Down buttons on the front of the TV or on the remote control respectively, so the TV will switch on and the **RED** Led will turn **GREEN**.

To switch the TV off

- Press the stand-by button on the remote control, so the TV will switch to stand-by mode and the **GREEN LED** will become **RED**, or,
- Press the power button located on the front of the TV.

Initial Settings

The message "**PLEASE CHECK ANTENNA CABLE AUTO. PROGRAMMING SYSTEM**" will be displayed when you turn on your TV for the first time.

1- Select **LANGUAGE** with the "**P ^**" or "**P v**" button, then press the "**◀**" or "**▶**" button to select a menu language.

2- Select **COUNTRY** with the "**P ^**" or "**P v**" button, then press the "**◀**" or "**▶**" button to select the country you are now located.

3- Select **START** with the "**P ^**" or "**P v**" button, then press the "**▶**" button to start APS.

APS (Automatic Programming System) automatically programmes the received channels in your TV's programme numbers. During APS, "**A. P. S. IS RUNNING**" will be displayed. After APS is finalized, the "**PROGRAM.**" menu appears.

To cancel APS, press the "**▶**" button.

You can delete a channel, insert a channel into a programme number, or re-start APS with the "**PROGRAM.**" menu.

For details, see "**Program. (Programming) Menu**" on **page 8**.

4- Press the "**STANDARD**" button to complete the initial settings.

After the initial settings are complete, you can change a programme number or to name a programme number or to programme new channel manually. For details, see "**Install. Menu**" on **page 7**.

If the message "**PLEASE CHECK ANTENNA CABLE AUTO. PROGRAMMING SYSTEM**" does not appear, follow the description "**Program. (Programming) Menu**" on **page 8** to select a menu language and the country where you are now located, and to use **A.P.S.**

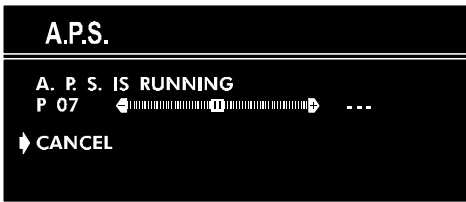
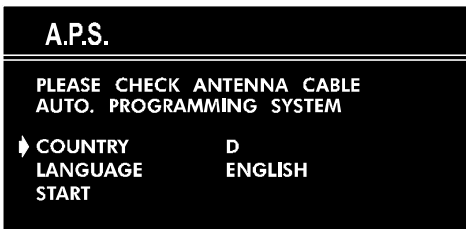

Operating with the onset buttons

Volume setting and programme selection can be made using the buttons on the front panel.

Volume Setting:

- Press “- ▴” button to decrease volume or “▴ +” button to increase volume, so a volume level scale will be displayed on the screen.

Programme Selecting:

- Press “P ▲” button to select next programme or “▼ P” button to select the previous programme.

Entering Main Menu:

- Press “MENU” button to enter main menu. In the main menu select submenu using “P ▲” or “▼ P” button and enter the submenu using “▴+” or “- ▴” button. To learn the usage of the menus, refer to “Menu System” on page 5.

Operating with Remote Control

The remote control handset of your TV is designed to control all the functions of the model you selected. The functions will be described in accordance with the menu system of your TV.

Functions which you can use out of menu system are described below.

Volume Setting:

Press “▴+” button to increase volume.

Press “- ▴” button to decrease volume.

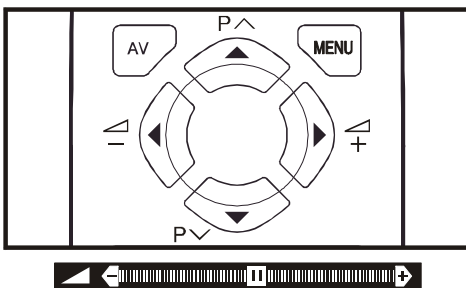

Programme Selecting (Previous or next programme):

- Press “P ▼” button to select the previous programme.
- Press “P ▲” button to select the next programme.

Programme Selecting (direct access):

Press digit buttons on the remote control handset to select programmes between 0 and 9. TV will switch to the selected program after a short delay.

When you press first digit, second digit will be displayed with ‘-’ symbol for 3 seconds. To select programmes between 10 and 99 press corresponding digit buttons consecutively before ‘-’ symbol on the second digit disappears. (e.g. for programme 27, first press 2 and then 7 while program number displayed as ‘2-’)

Menu System

Your TV has been designed with a menu system. Display “MENU” (main menu) and enter one of five menus (**SOUND**, **PICTURE**, **FEATURE**, **INSTALL.** and **PROGRAM**).

- 1- Press “MENU” button to display “MENU” (main menu). The menu titles will be displayed in the main menu.
- 2- Press “P ▲” or “P ▼” button to select a menu title, then press “◀” or “▶” button to enter the menu.
 - To exit a menu, press “STANDARD” button.
 - To go to the previous menu, press “MENU” button.

Sound Menu

To change sound settings:

- Press “MENU” button, now you are in main menu. In the main menu, select **SOUND** using “P ▲” or “P ▼” button, then enter the sound menu pressing “◀” or “▶” button.

or,

- Enter the Sound Menu directly, pressing the **RED** button.

Setting Volume:

As you enter the sound menu, Volume will be the first selected option.

- Press “▶” button to increase volume.
- Press “◀” button to decrease volume.



Setting Balance:

- Using “P ▲” or “P ▼” button select Balance.
- Press “▶” button to change balance rightward.
- Press “◀” button to change balance leftward.

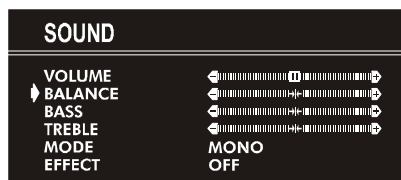

Setting Bass Level:

- Using “P ^” or “P v” button select Bass.
- Press “▶” button to increase bass level.
- Press “◀” button to decrease bass level.

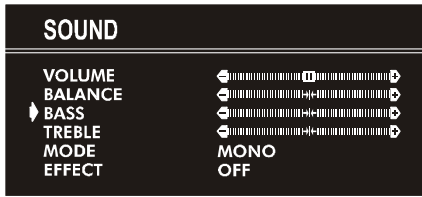

Setting Treble Level:

- Using “P ^” or “P v” button select Treble.
- Press “▶” button to increase treble level.
- Press “◀” button to decrease treble level.

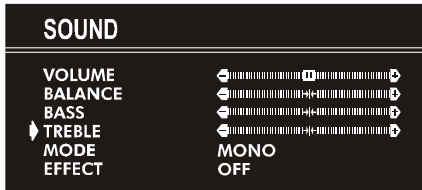

Selecting Mode:

You can choose **MONO**, **STEREO** or **DUAL I-II** mode, only if the selected channel supports that mode.

- Using “P ^” or “P v” button select Mode.
- Press “◀” or “▶” button to change Mode.
- If the TV channel you are watching broadcasts in two languages (e.g. Eurosport), you can select the dubbed or the original language.
- When the stereo broadcast is received poorly, you can change from stereo to mono sound so that you can hear the broadcast more clearly and easily.

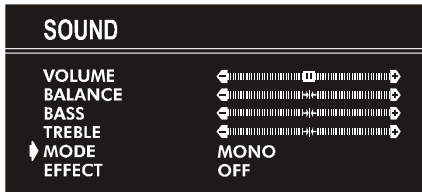

Setting Effect:

You can use this feature to switch on and off sound effect. Pressing “◀” or “▶” button will turn on and off this feature. If the current sound system is **mono** and the sound effect is set **ON**, then the sound will be heard as if it is **stereo**. If the current sound system is **stereo**, switching this effect on will make the sound deeper. Switching it off will make no change in **mono** and **stereo**.

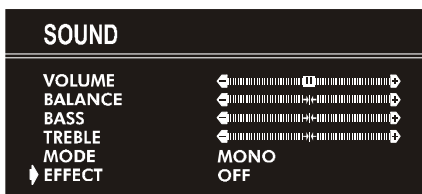

Picture Menu

To change picture settings:

- Press “MENU” button, now you are in main menu. In the main menu, select **PICTURE** using “P ^” or “P v” button, then enter the picture menu pressing “◀” or “▶” button.

or,

- Enter the Picture Menu directly, pressing the **GREEN** button.

Setting Brightness:

- As you enter the picture menu, **BRIGHTNESS** will be the first selected option.
- Press “▶” button to increase **BRIGHTNESS**.
- Press “◀” button to decrease **BRIGHTNESS**.



Setting Contrast:

- Using “P ^” or “P v” button select **CONTRAST**.
- Press “▶” button to increase **CONTRAST** level.
- Press “◀” button to decrease **CONTRAST** level.



Setting Colour:

- Using “P ^” or “P v” button select **COLOUR**.
- Press “▶” button to increase **COLOUR** level.
- Press “◀” button to decrease **COLOUR** level.



Setting Sharpness:

- Using “P ^” or “P v” button select **SHARPNESS**.
- Press “▶” button to increase **SHARPNESS** level.
- Press “◀” button to decrease **SHARPNESS** level.



Setting Hue (In AV mode only) :

- Using “P ^” or “P v” button select HUE.
- Press “▶” button to increase HUE level.
- Press “◀” button to decrease HUE level.

HUE adjust is functional only when NTSC 3.58/4.43 is applied in AV mode. It does not appear when other colour systems used.



Mode:

This option is used to change the picture size according to the coming transmission.

- If **AUTO** function is selected, then the picture size will be automatically changed according to the transmission.
- Selecting **4 : 3** mode forces picture ratio size to **4 : 3**.
- Selecting **16 : 9** mode forces picture ratio size to **16 : 9**.

Every program has its own picture mode setting. When you store the picture mode for a program other programs keep their picture mode setting unaffected.



Feature Menu

- Press “MENU” button, now you are in main menu. In the main menu, select **FEATURE**, using “P ^” or “P v” button. Then enter the feature menu pressing “◀” or “▶” button.

or,

- Enter the Feature Menu directly, pressing the **YELLOW** button.

Sleep Timer:

- As you enter the feature menu, **SLEEP TIMER** will be the first selected option.
- Use “◀” or “▶” button to change the value of the sleep timer between **OFF, 0:15:00, 0:30:00, 0:45:00, 1:00:00, 1:15:00, 1:30:00, 1:45:00** and **2:00:00** hours. Your TV will get into standby mode when the period you selected passes after you make the selection.

It is displayed on the upper right of the screen. If sleep timer is activated it is displayed with the TV status and erased with it after 3 seconds.

0:15 : 00

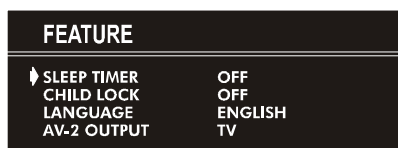

During the last minute of the count down, the timer is displayed on the upper right of the screen. When the timer reaches zero, TV goes to stand-by.

Child Lock:

In Feature Menu, press “P ^” or “P v” button to select **CHILD LOCK**. Using “◀” or “▶” button turn **CHILD LOCK** On or Off.

When Off is selected, there will be no difference in the operation of your TV. When On is selected, the TV can only be controlled by the remote control handset. In this case, the front panel buttons (except the Switch On/Off button) will not work.

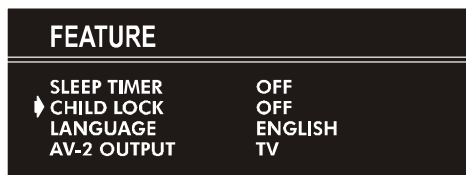

Language:

Menu Language can be selected by pressing “◀” or “▶” button on **LANGUAGE** item.

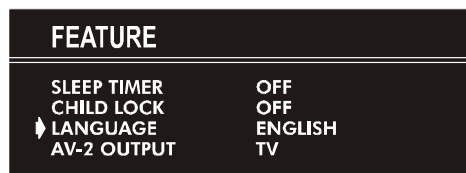

AV-2 Output:

You can use this feature to select the internal or external source that will be output at **AV-2 (EXT.2)** terminal.

TV or **AV-1** can be chosen by pressing “◀” or “▶” button on “**AV-2 OUTPUT**”.



Install. Menu

- Press “MENU” button, now you are in main menu. In the main menu, select **INSTALL.** using “P ^” or “P v” button, then enter the Installation menu pressing “◀” or “▶” button.

or

- Enter the Installation Menu directly, pressing the **BLUE** button.

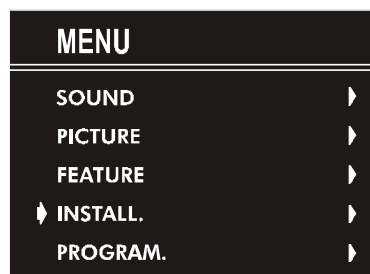

To programme a channel in a TV's programme number manually:

1. **PROGRAMME** will be the first selected item as you enter the **INSTALL.** menu. Pressing "◀" or "▶" button select the programme number where you want to the tuned channel to be stored. (You may also type the programme number using the digit buttons.)

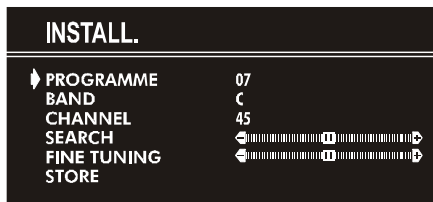

2. Press "P ^" or "P v" button to select **BAND**. Using "◀" or "▶" button to select the band in which you want to search a channel.
3. Press "P ^" or "P v" button to select **SEARCH**. Press "◀" or "▶" button to start searching. (Press "▶" button to search forward. Press "◀" button to search backwards.)

If the found channel is not the desired one, press "◀" or "▶" button to start searching again.

To stop searching before a channel is found, press the reverse direction button. For example, when the TV is searching forward with "▶" button, press "◀" button to stop searching.

If you know the channel number which you want to find, you can find the channel directly.

Press "P ^" or "P v" button to select **CHANNEL**, then press "◀" or "▶" button to select the channel number, or enter the number with the digit buttons.

4. If you want to name the new programme, follow the instructions under "**To change the name of a programme**" on page 8.
5. If the channel reception is poor, fine-tune the channel. Press "P ^" or "P v" button to select **FINE TUNING**, then press "◀" or "▶" to fine-tune the channel.
6. After the all settings are completed, store the new channel's setting to the programme number which you selected. Press "P ^" or "P v" button to select **STORE**, then press "◀" or "▶" to store it.

If you want to modify the current programme number's setting (for example, changing fine tuning, etc.):

1. Select the programme number you want to modify the settings while no menu appears.
2. Display the **INSTALL.** menu.
3. Follow "**To programme a channel in a TV's programme number manually.**" on page 8 and change the settings of the current programme number.

If you want to name the new programme, follow the instructions under "To change the name of a programme" on page 8.

Note:

Do not use Programme item in the **INSTALL.** menu to select the programme number. If you select the programme number with Programme item and store the settings, the selected programme number's current settings are cancelled.

Program. (Programming) Menu

PROGRAM. (Programming) menu is used to display the programme names and numbers. You can use this menu to delete a channel, to insert a channel and to autostore the programmes.

Select the **PROGRAM.** menu pressing "P ^" or "P v" button and open it pressing "◀" or "▶" button. When you enter the programme menu, all the programme numbers and names will be displayed on the screen. The programme number and name of the tuned channel will be shown by the cyan color. All the other channel numbers will be white. You can move the number in cyan using "P ^" or "P v" or "◀" or "▶" button. Also, it's possible to use digit buttons to select programme numbers. As you pass through the programme numbers this way, to reach the programme number you want, the channels corresponding to the programme numbers you pass through will be tuned and the selected programme number will be shown in cyan.

PROGRAM.			
◀ 01	C-01	11	----- 21 -----
02	C-02	12	----- 22 -----
03	C-03	13	----- 23 -----
04	C-04	14	----- 24 -----
05	C-05	15	----- 25 -----
06	C-06	16	----- 26 -----
07	-----	17	----- 27 -----
08	-----	18	----- 28 -----
09	-----	19	----- 29 -----
10	-----	20	----- 30 -----
■	NAME	■	DELETE
■	INSERT	■	A.P.S.

To change the name of a programme:

- Move to the channel you want to rename or use the digits so that the selected programme number is in cyan color.
- Press the **RED** button. Use "◀" or "▶" button to select the position and press "P ^" or "P v" button to select a letter.

Now, press the **RED** button again to store or **BLUE** button to cancel **NAME**.

To delete a channel from a programme number:

- Move to the channel you want to delete or use the digits so that the selected programme number is in cyan color.
- Press the **YELLOW** button. Now the corresponding channel will be deleted and all the other channels below this programme number will be moved one programme number up.

Now, press the **YELLOW** button again to delete or **BLUE** button to cancel **DELETE**.

To insert a channel into a programme number:

- Move to the channel to be inserted or use the digits so that the selected programme number is in cyan color.
- Press the **GREEN** button. Now using "P ^" or "P v" or "◀" or "▶" buttons, move to the programme number.

Now, press the **GREEN** button again to insert or **BLUE** button to cancel **INSERT**.

A.P.S.

If you enter the **A.P.S.** menu, you can automatically programme the received channels in your TV's programmes with **A.P.S.** (Automatic programme system).

1. After displaying the **PROGRAM.** menu, press the **BLUE** button to enter the **A.P.S.** menu.
2. Select **LANGUAGE** with the "P ^" or "P v" button, then press the "◀" or "▶" button to select a menu language.

3. Select **COUNTRY** with the “P ^” or “P v” button, then press the “>” or “<” button to select the country you are now located.
 4. If you want to start programming, select **START** with the “P ^” or “P v” button, then press the “>” button. The message “**A.P.S. IS RUNNING**” appears and **A.P.S.** automatically programmes the received channels in your TV’s programme numbers. After **A.P.S.** is finalized, the **PROGRAM.** menu appears again.
- To cancel **A.P.S.**, press the “>” button.

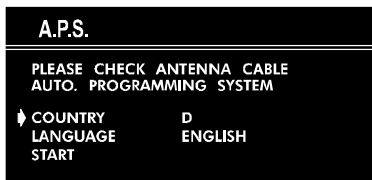

Other Features

Sound Mute

To cut off the sound of the TV, press “M” button. The sound will be cut off. To cancel mute, press “M” or “-” or “+” button. The volume level will be the same as the level before mute when you cancel mute.

Information on Screen

First pressing the “i” button displays the current status “**Programme number**”, “**Station name**” and “**Sound status**”.

Pressing this button again displays the current time.

Pressing this button once more remove the on-screen display.

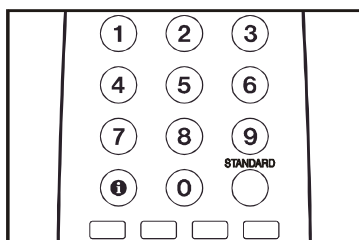

To Display the Time

- While watching a TV programme with Teletext transmission press “i” button twice. The current time information, captured from Teletext will be displayed on the screen.
- If the programme being watched does not have Teletext transmission, only a box will be displayed at the same location.
- The time information will disappear after pressing “i” button again.

When time information is displayed on screen, entering another menu will remove it.

Standard

You can re-set the current **PICTURE** menu settings (except Picture Mode setting) to the default settings.

- Press “**STANDARD**” button when no menu appears.

VCR Control Buttons

The buttons can be used to operate a JVC brand VCR. Pressing the button having the same appearance as the original remote control button of a device makes the function work in the same way as the original remote control.

Press the VCR Control Button to control your VCR.

Note:

- If your device is not made by JVC, these buttons cannot be used.
- Even if your device is made by JVC, some of these buttons or any one of the buttons may not work, depending on the device.
- You can use the ^ / v buttons to choose a TV channel which the VCR will receive.

Teletext

Teletext is an information system that displays text on your TV screen. Using the Teletext information system you can view a page of information on a subject that is available in the list of contents (index).

No on screen display will be available in text mode.

No contrast, brightness or colour control, but volume control is available in text mode.

To operate Teletext

- Select a TV station on which Teletext is being transmitted.
- Press (TELETEXT) “T” button. Usually the list of contents (index) is displayed on the screen.

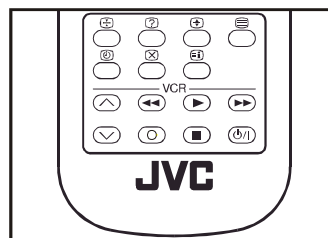

To select a page of Teletext

- Press the appropriate digit buttons for the required Teletext page number.

The selected page number is displayed at the top left corner of the screen. The Teletext page counter searches until the selected page number is located, so that the desired page is displayed on the screen.



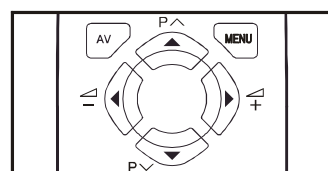

- Press “P ^” button to move the Teletext screen forward one page at a time.
- Press “P v” button to move the Teletext screen backward one page at a time.





To Select Index Page

- To select the page number of the index (generally page 100), press “” button.



Searching for a teletext page while watching TV

- In the Teletext mode pressing “” button will switch the screen to the TV mode. In the TV mode enter a page number using digit keys. As you enter last digit of page number, “” sign will replace the page number and flash until the entered page number is found. Then the page number will replace “” sign again. Now you can display this teletext page pressing “” button.

To Select Double Height Text



- Press “” button for the top half of the information page to be displayed in double height text.
- Press “” button again for the bottom half of the information page to be displayed in double height text.
- Press “” button once more for the full page of normal height text.

To Reveal “concealed” Information

- Pressing “” button once will reveal answers on a quiz or games page.
- Pressing “” button again will conceal the revealed answers.



To Stop Automatic Page Change

The teletext page you have selected may contain more information than what is on the screen; the rest of the information will be displayed after a period of time.

- Press “” button to stop the automatic page change.
- Press “” button again to allow the next page to be displayed.

To Select a Subcode Page

Subcode pages are subsections of long Teletext pages that can only be displayed on the screen one section at a time.

- Select the required Teletext page.
- Press “” button.
- Select the required subcode page number by pressing four digit buttons (e.g. 0001).
- If the selected subcode page is not displayed in a short time, press “” button. TV programme will be displayed on the screen.
- Teletext page number will be displayed on the upper left corner of the screen when the selected page is found.
- Press “” button to display the selected Teletext page.

To exit Teletext

- Press “” button. The screen will switch to TV mode.

Fastext and Toptext

Teletext mode will be selected according to transmission automatically.

Your TV supports the 7 page Teletext system. When the page number of any of the 7 pages in memory is entered, the system will not search for the requested page; instead it will display the page automatically.

- Press “**P ^**” button to move the Teletext screen forward one page at a time.
- Press “**P v**” button to move the Teletext screen backward one page at a time.

For Fastext and Toptext:

The subject-heading for the information may have a particular colour or can be in a form located in a coloured box.

- Press an appropriate **RED, GREEN, YELLOW** or **BLUE** button in order to reach the relevant page quickly.

For Toptext:

If Toptext transmission is present, colour coded buttons will appear in status row.

If Toptext transmission is not present, status row will not appear.

In Toptext mode the “**P ^**” or “**P v**” commands will request the next or previous page respectively. If Toptext transmission is not available, in case of operation of these commands, wraparound occurs. For example page 100 appears to be one greater than page 199.

Connect the External Equipments

Before connecting anything

- Switch off all equipments including the TV.
- Read the manuals provided with the equipments.

To select an AV mode

Pressing “AV” button on the remote control selects one of four AV modes (**AV- 1**, **AV-2**, **AV-2 S** and **F-AV**).

- To return to the TV mode, repeatedly press “AV” button or press “P ^” or “P v” button.

AV-1 (EXT.1) terminal: Euroconnector (21-pin, SCART)

- Video input, Audio L/R inputs and RGB inputs are available.
- TV broadcast outputs (Video and Audio L/R) are available.

AV-2 (EXT.2) terminal: Euroconnector (21-pin, SCART)

- Video input, S-VIDEO (Y/C) input and Audio L/R inputs are available.
- Video and Audio L/R outputs are available.

F-AV (Front AV) terminal: RCA connectors x 3

- Video input and Audio L/R inputs are available.

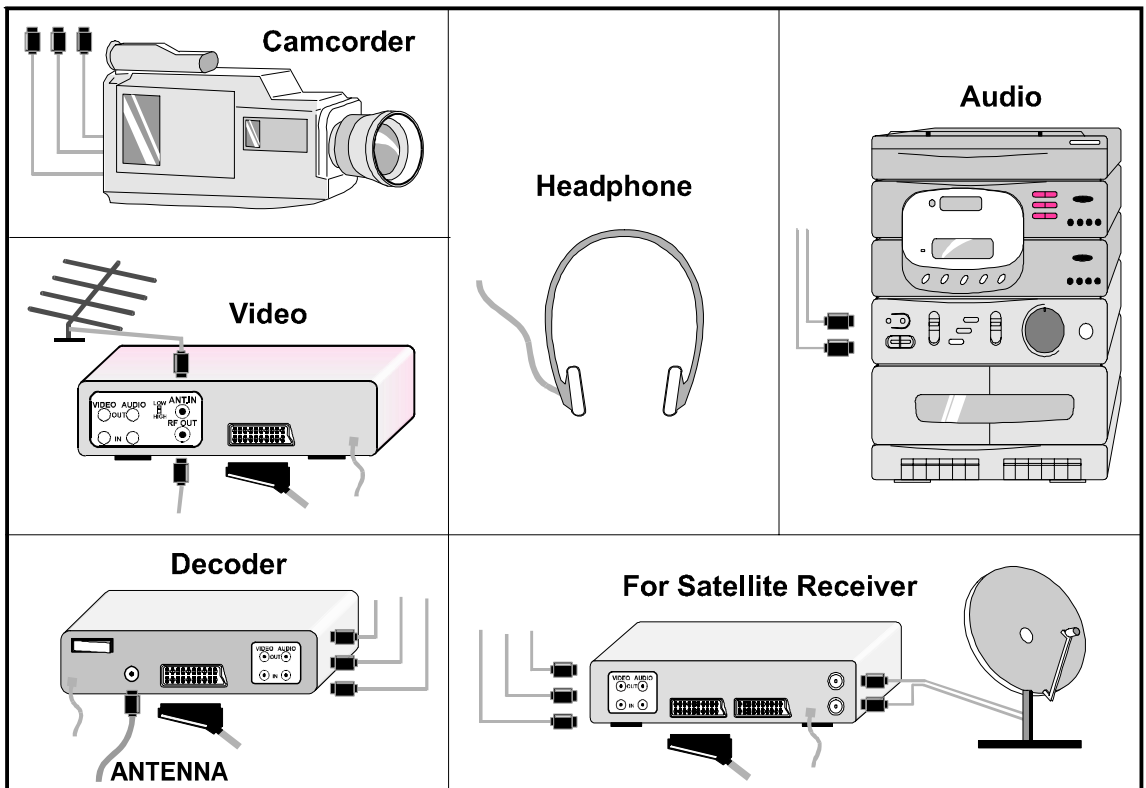
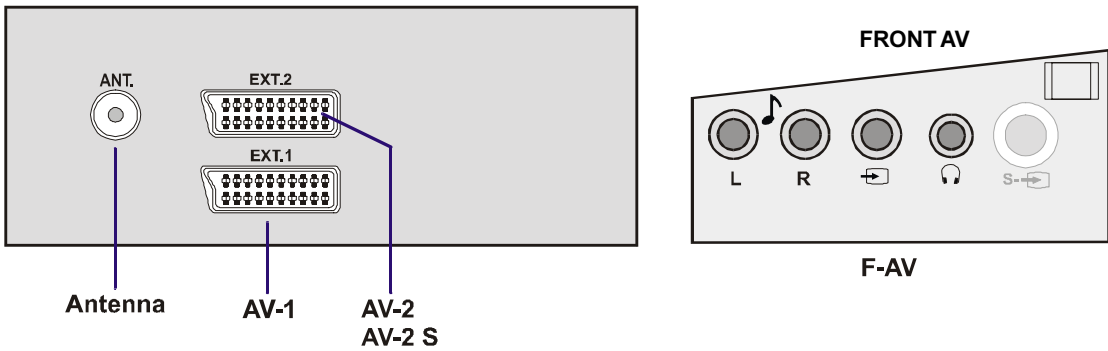

Via the Euroconnector

Your TV set has two Euroconnector sockets. If you want to connect equipments (e.g. video recorder, decoder, etc.) which have Euroconnectors, to your TV, use the **AV-1 (EXT.1)** or **AV-2 (EXT.2)** terminals.

If an external device is connected via Euroconnector sockets TV is switched to AV mode automatically.

RGB mode

If an equipment can output the **RGB** signals, connect it to the **AV-1 (EXT.1)** terminal.

AV-2 S Mode

If the equipment connected to your TV set supports S-Video (Y/C) output from Euroconnector, you can have a better picture quality by selecting **AV-2 S** mode and connecting your equipment to the **AV-2 S (EXT.2)** terminal of TV. See your equipment's booklet to check if your equipment has such feature.

Via the RCA jacks

If you have an equipment (such as a Camcorder) which has the RCA jacks, connect it to the **F-AV (Front AV)** terminal with the video and audio cables.

- If the equipment has the mono audio jack, connect it to the **AUDIO-L** jack.

Via the ANT (aerial) socket

If your equipment does not have an Euroconnector or RCA jacks, connect it to the TV with an aerial cable. For details, see the manual provided with the equipment.

- To store the test signal that comes from the equipment, see "**Install. Menu**" on **page 7** and store it to the programme number 0. You can watch images from that equipment to select the programme number which you stored the test signal.

TV and Video Recoder (VCR)

- Connect the Video Recorder to the ANT (antenna input) socket of the TV with the aerial cable.
- Connect the Video Recorder to the **AV-1** or **AV-2** terminal with the SCART cable, or connect it to the **F-AV (Front AV)** terminal with the audio and video cables.

NTSC Playback

Connect a NTSC video recorder to a terminal. Then press "**AV**" button to select the corresponding AV mode.

NTSC 3.58/4.43 system is detected automatically in AV mode.

Copy Facility

You can output the video and audio signals which inputs from **TV** or **AV-1 (EXT.1)** terminal to the video recorder connected to the **AV-2 (EXT.2)** terminal.

- To select the output source, see "**AV-2 OUTPUT**" on **page 7**.

Connecting Headphones

Use the stereo headphone socket of your TV, to connect headphones.

Tips

Care of the Screen

Clean the screen with a slightly damp, soft cloth. Do not use abrasive solvents as they may damage the TV screen coating layer.

Poor Picture

Have you selected the correct TV system? Is your TV set or house aerial located too close to the loudspeakers, non-earthed audio equipment or neon lights, etc. ?

Mountains or high buildings can cause double pictures or ghost images. Sometimes you can improve the picture quality by changing the direction of the aerial.

The picture quality may degrade when two peripherals are connected to the TV at the same time. In such a case, disconnect one of the peripherals.

No Picture

Is the aerial connected properly? Are the plugs connected tightly to the aerial socket? Is the aerial cable damaged? Are suitable plugs used to connect the aerial? If you are in doubt, consult your dealer.

No Picture means that your TV is not receiving any transmission. Have you pressed the correct keys on the remote control? Try once more.

Sound

Sound is coming from only one of the speakers. Is the balance set to one direction extreme? See **SOUND** menu.

Remote Control

Your TV no longer responds to the remote control. Press the "**STANDARD**" button on the remote control once more. Perhaps the batteries are exhausted. If so you can still use the local buttons at the front of your TV.

Have you selected the wrong menu? Press "**STANDARD**" button to return to TV mode or press "**MENU**" button to return to the previous menu.

No solution

Switch your TV set off and on. If this does not work, call the service personnel; never attempt to repair it yourself.

Specifications

TV BROADCASTING	PAL B/G
RECEIVING CHANNELS	VHF (BAND I/III) UHF (BAND U) HYPERBAND CABLE TV (S01-S41 / S75-S79)
NUMBER OF PRESET CHANNELS	100
CHANNEL INDICATOR	On Screen Display
RF AERIAL INPUT	75 Ohm (unbalanced)
OPERATING VOLTAGE	220-240V AC, 50 Hz.
SOUND-MULTIPLEX SYSTEMS	Nicam + German Stereo
PICTURE TUBE	For 28"
AUDIO OUTPUT POWER (W_{RMS}) (%10 THD)	2 x 10
POWER CONSUMPTION (W) (max.)	135
DIMENSIONS (mm)	<u>AV-28KM3SN</u>
D	480
L	770
H	580
Weight (Kg.)	33,2